

CARACTERÍSTICAS TÉCNICAS

COLORES

ENCIMERA

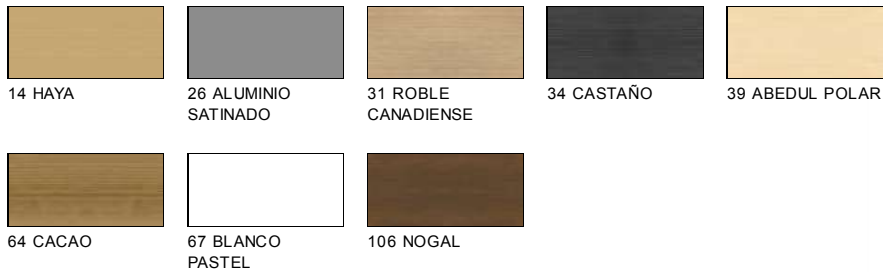

ESTRUCTURA

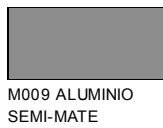

TAPÓN PASACABLES - NEGRO



TAPÓN PASACABLES - BLANCO



TAPÓN PASACABLES - ALUMINIO



SOBRE

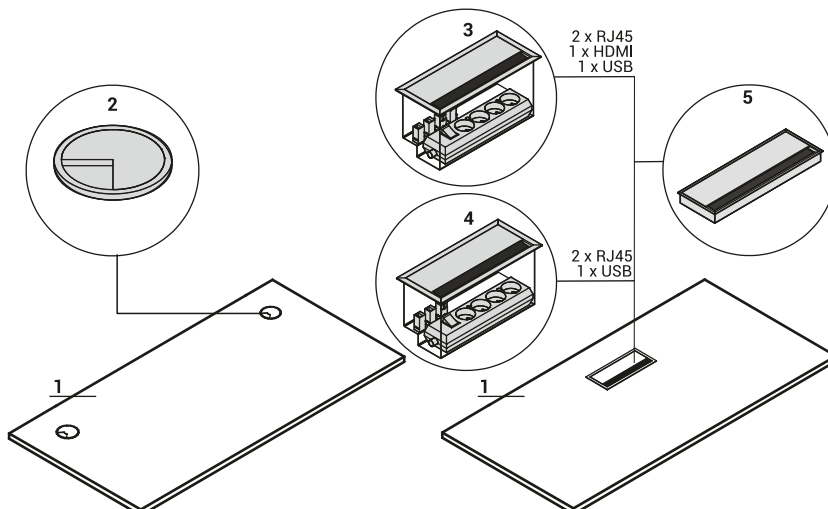

1. Encimera - MFC 28mm, cantos PVC
2. Opción con recargo - 2 x tapones pasacables PVC - \varnothing 80mm
3. Opción con recargo - Mediabox M04H - 2xRJ45 (class E, cat. 6) +1 x USB + 1 x HDMI + 4x 230V, color M009- aluminio semi-mate
4. Opción con recargo - Mediabox M04 - 2xRJ45 (class E, cat. 6) +1 x USB + 4x 230V, color M009- aluminio semi-mate
5. Opción con recargo - Tapa acceso superior M05 - color M009 - aluminio semi-mate

CARACTERÍSTICAS TÉCNICAS

ENCIMERAS - CONFIGURACIONES

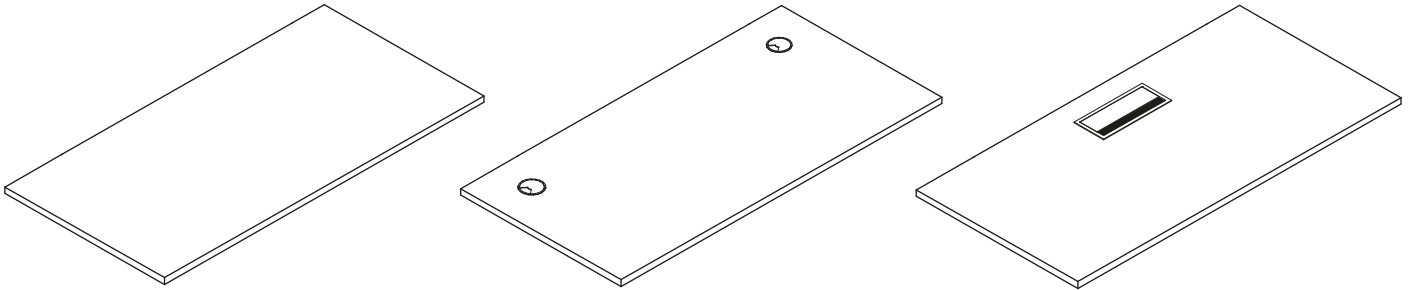

ESTRUCTURA

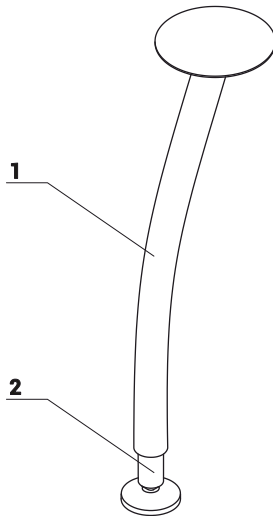

1. Pata - acero lacado
2. Regulación de altura - 685-785mm

ACCESORIOS

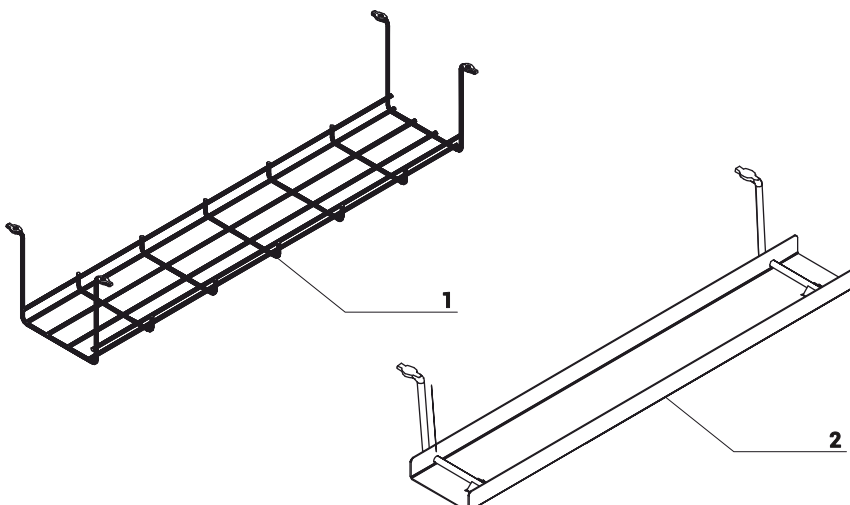



1. Bandeja pasacables horizontal S69 - lacado, color: 09- aluminio
2. Bandeja pasacables horizontal E64 - lacado, color: M009- aluminio semi-mate

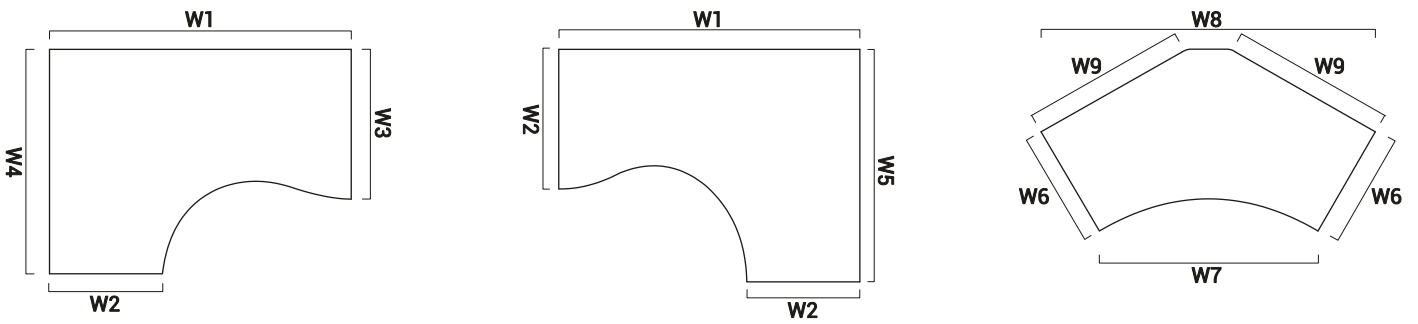

CARACTERÍSTICAS TÉCNICAS





W1 - 1600mm | W2 - 600mm | W3 - 800mm | W4 - 1200mm | W5 - 1000mm | W6 - 600mm | W7 - 1143mm | W8 - 1743mm | W9 - 845mm

ILUSTRACIÓN DE PRODUCTO	DIMENSIONES [mm]			REFERENCIA						COMENTARIOS
	LARGO	PROFUNDIDAD	ALTURA			kg	m3	pcs		

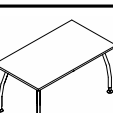
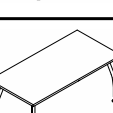
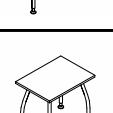
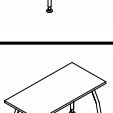
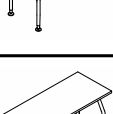
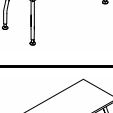
ESCRITORIOS

	800	800	740	BA1		18.0	0.068	2		
	1200	800	740	BA3		24.8	0.080	2		
	1400	800	740	BA4		28.1	0.085	2		
	1600	800	740	BA5		31.0	0.092	2		
	800	600	740	BA61		15.9	0.063	2		
	1200	600	740	BA63		20.7	0.071	2		
	1400	600	740	BA64		21.0	0.076	2		
	1600	600	740	BA65		23.0	0.080	2		

RECARGO ADICIONAL

CARACTERÍSTICA	PRODUCTO												COMENTARIOS
	BA1	BA3	BA4	BA5	BA61	BA63	BA64	BA65		kg	m3	pcs	
TAPONES PASACABLES										0.1	0.0001	1	
MEDIABOX M04H										0.9	0.0070	1	
MEDIABOX M04										0.9	0.0070	1	
TAPA ACCESO SUPERIOR M05										0.0	0.0000	0	

DESCRIPCIÓN:











 - PESO NETO - VOLUMEN - NÚMERO DE PAQUETES

ILUSTRACIÓN DE PRODUCTO	DIMENSIONES [mm]			REFERENCIA					COMENTARIOS
	LARGO	PROFUNDIDAD	ALTURA			kg	m3	pcs	

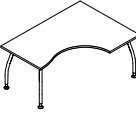

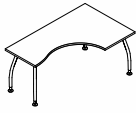
ESCRITORIOS RADIALES

	1600	1200	740	BA10		35.0	0.115	2	
	1600	1200	740	BA11		35.0	0.115	2	
	1600	1000	740	BA66		32.0	0.102	2	
	1600	1000	740	BA67		29.8	0.104	2	
	1743	955	740	BA20		32.5	0.106	3	

RECARGO ADICIONAL

CARACTERÍSTICA	PRODUCTO													COMENTARIOS
	BA10	BA11	BA66	BA67							kg	m3	pcs	
TAPONES PASACABLES											0.1	0.0001	1	
MEDIABOX M04H											0.9	0.0070	1	
MEDIABOX M04											0.9	0.0070	1	
TAPA ACCESO SUPERIOR M05											0.0	0.0000	0	

DESCRIPCIÓN:

 - PESO NETO - VOLUMEN - NÚMERO DE PAQUETES

